

Door systems and sliding systems



»» Why WICONA?

Because as a successful aluminium systems company based in Germany, WICONA has more than 60 years' experience – experience from which you can benefit on a daily basis. Not only are we able to fulfil the role of a reliable and cooperative supplier, but you can also enjoy the

advantages of a strong, technologically advanced brand that has enjoyed long-term success in the market. At WICONA, every detail counts: from efficient planning and processing and rapid delivery right through to active sales support. That's why WICONA!



What does WICSTYLE mean for metal construction?

The WICSTYLE system technology has been developed further according to our guideline “technology for ideas”. The objective was to fulfil all requirements and expectations from architects or investors in regards of design and most efficient thermal insulation. Many years of practical experience from metal builders using our systems guarantee a

maximum orientation towards an efficient and reliable fabrication. All requirements from international standards, CE-directives and technical regulations are met in highest classifications. As a result WICSTYLE evo offers you a clear advantage in economy, technology and sustainability.

WICSTYLE evo – simply better	4
WICONA Unisys A system that meets all requirements	6
Sustainability Environmental responsibility during the entire lifecycle	8
Technology for your ideas Design, threshold and corner connection technology Hinge and lock technology, cover plates and gaskets	10 12
Door systems WICSTYLE 65 evo Hinged door WICSTYLE 75 evo Hinged door	14 15
Door options Hinged door / Leaf overlapping infills / Classic design Finger protection door / Double action door / All-glass door	16
WICSTYLE series for special requirements WICSTYLE 50N / 65N Mon-insulated door WICSTYLE 77FP Fire protection door WICSTYLE Panic / escape door	18 19 20 21
Comfort access with efficient thermal insulation WICSTYLE 65ED Energy-saving automatic sliding door	22
WICSLIDE sliding units – simply closer to nature WICSLIDE 160 Lifting sliding door WICSLIDE 65FS Folding sliding door WICSLIDE 23 Lifting sliding door WICSLIDE 26 Lifting sliding door WICSLIDE 24E / 24EN Sliding door	24 26 27 28 29 30
WICONA: Solutions for ambitious architecture	31



WICSTYLE EVO

» WICSTYLE evo – simply better





Performance

- Thermal insulation U_d until below 0.8 W/(m²K), thus enabling even passive house constructions
- Performing sound insulation values until 43 dB
- Reliable tightness, with high classifications for CE marking
- Versatile application: hinged doors, double action doors, finger protection doors, all-glass doors, various infills, with fixed or opening fanlight, side elements, insertion in curtain walls, with additional functions like burglar resistance or bullet resistance
- Big sizes no problem: leaf dimensions until 1300 mm x 2520 mm and leaf weights up to 200 kg
- One butt hinge for all system depths, for inward and outward opening

Design

- Flush leaf design inside and outside, for a straight design without offset
- Alternative: Classic design with bevelled contours
- Leaf overlapping infills on one side and on both sides possible
- Special optical covers in the rebate area for smooth surfaces, with flush integration of all components
- Hinges in two options, surface anodised or powder coated
- Individual threshold solutions
- Comprehensive range of variations for individual planning and implementation

Efficient fabrication

- Consistent modular concept according to the WICONA Unisys technology
- Unique fixing technology for the hinges: simplified assembly and change, e.g. supplementary hinges are possible at any time without dismantling
- Easy, rapid and reliable lock fixation in the insulation bars
- Patented WICONA corner connection technology, with glue injection from only one side and guided distribution
- Covers in the rebate area simply to clip in
- One butt hinge for inward and outward opening doors, for all system depths



» One system for all requirements

WICSTYLE 65 evo

Inward opening with special frame

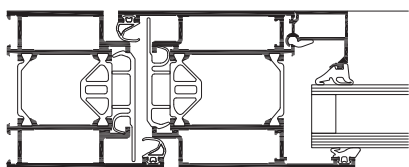

WICSTYLE 75 evo

Inward opening with combination frame

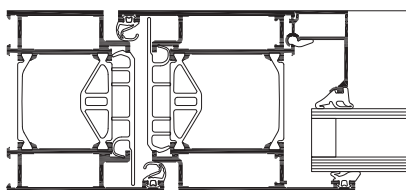

WICSTYLE 65 / 75 evo

Outward opening with special frame

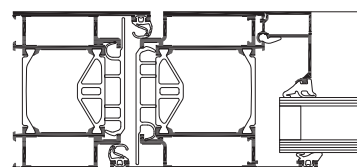

WICSTYLE 65 / 75 evo

Double sash outward opening

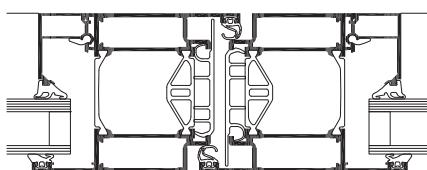

WICSTYLE 65 / 75 evo

Finger protection door

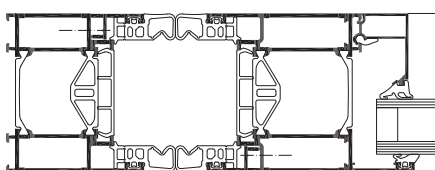

WICSTYLE 65 / 75 evo

Stick system integration

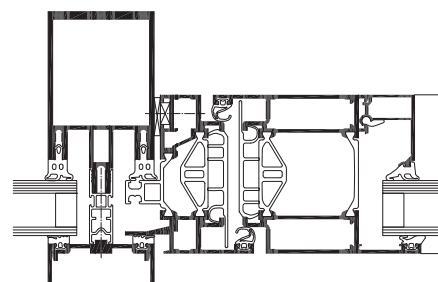

WICSTYLE 65 evo

Double action door type 1 (also finger protection door)

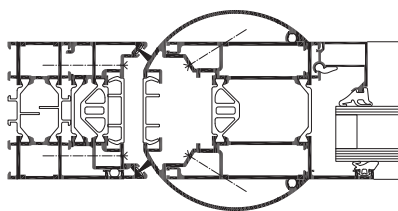

WICSTYLE 65 evo

Double action door type 2

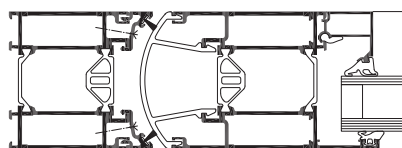

WICSTYLE 65 / 75 evo

Classic design

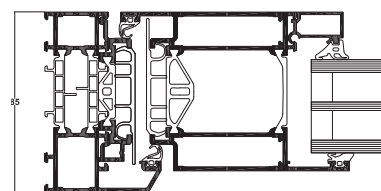



Examples for the WICONA Unisys principle:

- Consistent modular design with identical components for the WICSTYLE 65 and 75 series
- Doors and windows due to an identical combination frame
- Congruent design in all applications and easy adaptation to further functions like
 - Burglar resistance until class RC3
 - Sound insulation until 43 dB
 - Thermal insulation until $U_i = 1.6 \text{ W}/(\text{m}^2\text{K})$, with additional insulation insert even better
 - Thermal insulation for doors until $U_d < 0.8 \text{ W}/(\text{m}^2\text{K})$
- Comprehensive choice of fittings and locks, which can be applied for several series
- As a result you always find the best solution for any architectural requirement with only one system

Efficient fabrication in every step

- WICSTYLE evo has been developed for maximum efficiency, process reliability and dependable results. Therefore many years of practical experience in the metal building workshops were integrated in the development.
- WICPRO offers the most adequate tools and fabrication means for each processing step.
- As a result you receive innovative technology coupled with most efficient processing in the daily metal building practice.

Your benefits

- Simplified logistics and less stock keeping due to identical components
- Simple planning, easy ordering and possible adaptations until short before the production
- Less time and effort in production due to identical processing steps
- Shorter production times due to efficient processing

- 1 | The same hinge applies to inward and outward opening doors and all system depths
- 2 | Functions such as emergency exits, burglary or bullet resistance feasible with simple modifications
- 3 | Examples for threshold options

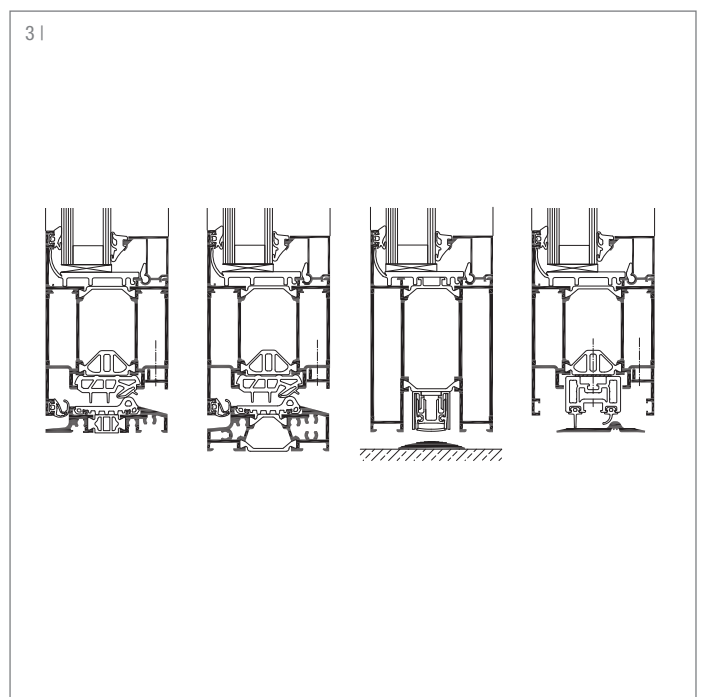
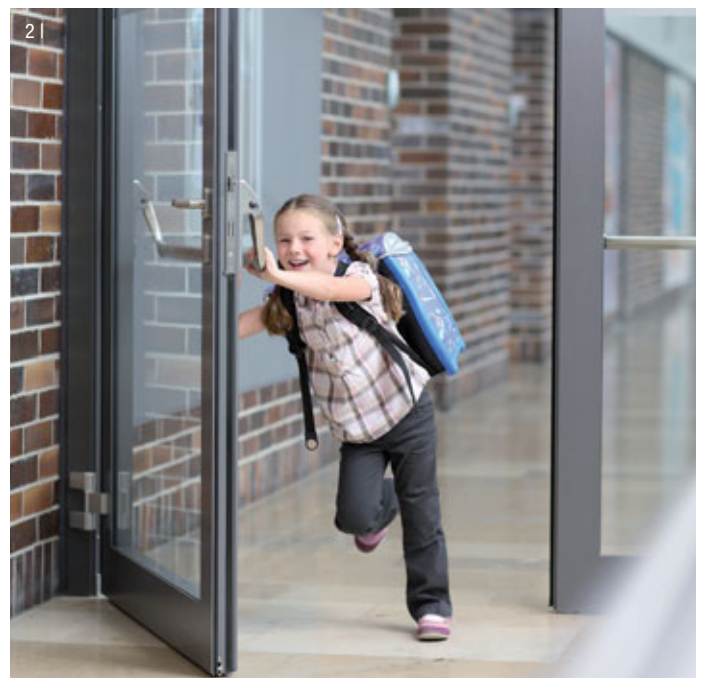

» Environmental responsibility during the entire lifecycle

Here at WICONA, we target the sustainability of buildings not only through thermal insulation, but also consider energy efficiency and climate protection during the entire lifecycle of the aluminium building material. Our philosophy is the

careful management of natural resources, starting with the aluminium production using 68 % of the energy from hydro power, up to recycling processes following the "cradle to cradle" philosophy.

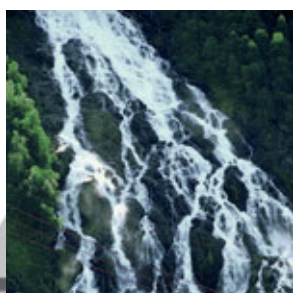

Aluminium production with hydro power



System development using eco-design



Recycling

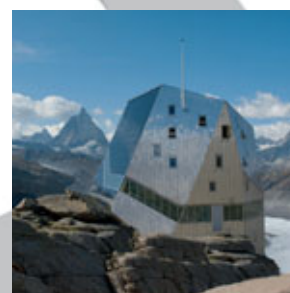

Energy-saving application

Your advantage: highest energy efficiency

WICSTYLE evo takes a big evolution step forward in thermal insulation performance. Its U_f values of down to $1.6 \text{ W}/(\text{m}^2\text{K})$, which can even be further improved with additional insulation inserts, make highest requirements an easy task.

And that with a standard implementation of the WICSTYLE evo door series. This efficiency is owed to optimisations in the profile and thresholds design, to improvements of fitting and lock integration in the thermal break bars, and to the thermal break technology with special insulating covers.

Your benefits

- The demands by the architect or the builder's requirements can easily be met
- Easy to obtain building certification with EPD (Environmental Product Declaration) for the WICONA components in the WICTOP Genius software
- Exemplary durability: tomorrow's standards are already met today, changes and upgrades can be implemented at any time

1 | Example: WICSTYLE 75 evo, with leaf overlapping infill

Door size as shown:

110 cm x 210 cm: $U_g = 0.79 \text{ W}/(\text{m}^2\text{K})$

Reference size (ift institute Rosenheim):

148 cm x 218 cm: $U_g = 0.69 \text{ W}/(\text{m}^2\text{K})$

2 | Example: WICSTYLE 65 evo, with glass infill

Door size as shown:

110 cm x 210 cm: $U_g = 1.4 \text{ W}/(\text{m}^2\text{K})$

Reference size (ift institute Rosenheim):

148 cm x 218 cm: $U_g = 1.3 \text{ W}/(\text{m}^2\text{K})$



» Your advantage: Technology for your ideas

A comprehensive profile range featuring an innovative thermal break technology with integrated screwing channel is the

base for outstanding performance. Upon this rest efficiency and quality of the complete WICSTYLE door series.



Profile technology
Thresholds and corner connections

1 | Individual design

- Ideal for the tailor-made adornment of each kind of buildings
- Comprehensive profile programme for a realisation of any customer demand and building integration
- Options like leaf-overlapping infills can easily be realised
- Design variations like classic design with angled shape, perfectly suiting the WICLINE evo windows in classic design

2 | Thresholds

Tightness, thermal insulation and operation comfort of a door are intensively influenced by the threshold technology. Here as well WICSTYLE evo sets new standards:

- High values in tightness against driving rain, wind, and also in sound insulation
- Thermal break for an optimised application in entrance doors
- Barrier free threshold easily possible
- Several options to choose from:
 - With mechanical stop
 - With lowering gasket
 - For renovations and refurbishments

3 | Corner connections

Solid corner connections are the basis for a long lasting function. The patented WICONA corner connection leads you to best results in a fast, easy and cost efficient way:

- Special corner angles with guided glue distribution
- Injection only from one side for time saving processing
- Ball valve technology for precise dosage and glue savings of up to 80 %

Your benefits

- The demands of architects or customers can easily be met
- Cost reduction due to shorter production times
- More possibilities in the implementation
- Reliable processing and minimised risk of error

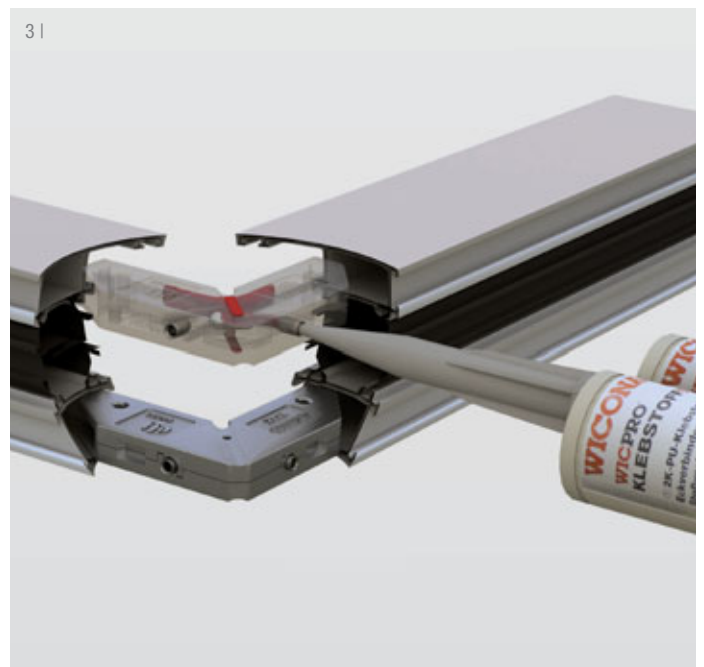
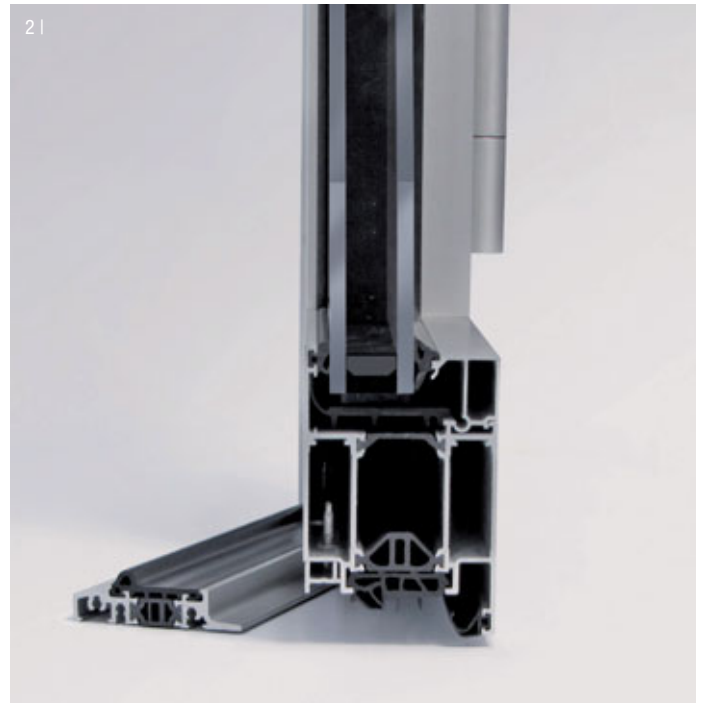

Fittings and locks

The WICSTAR evo fittings offer unique advantages

1 | Butt hinges

- One butt hinge type for inward and outward opening and for all system depths
- For leaf weights up to 150 kg
- High quality in aluminium, for powder coating or anodisation
- Time saving and efficient assembly due to clamping technology:
 - Just position the parts, fix them, that's it
- Posterior installation possible, without any profile processing
- Easy and quick adjustment of the installed door leaf

2 | Screw-on hinges

- For leaf weights up to 200 kg
- One hinge type for inward and outward opening
- With screw channel technology, no need for fixture plates
- Easy and quick adjustment of the installed door leaf

3 | Lock integration

- Innovative positioning of the locks in the thermal break profile for improved thermal insulation and simplified processing
- No need for pre-drilling due to direct screw fixation in the integrated screwing channel

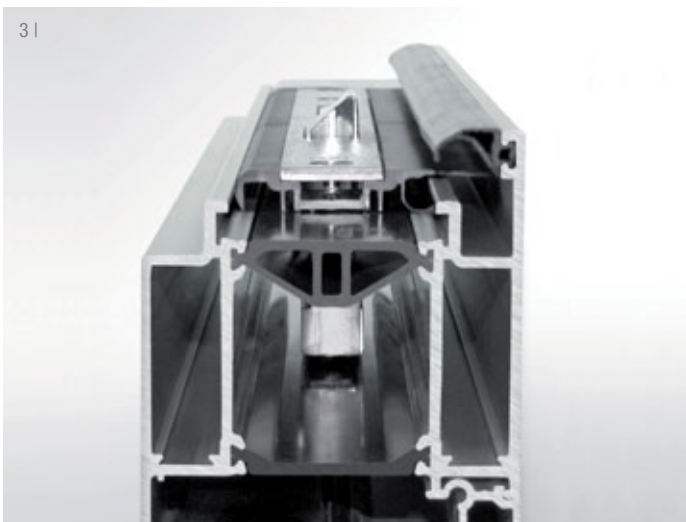

Covers and gaskets

4 | Locks

- WICONA Unisys concept with many variants and extensions for further requirements like overhead door closer, manual or automatic multiple locks or E-openers
- Panic / escape door acc. to EN 179 / EN 1125 in various lock and handle options, possible combination with other functions

5 | Covers

- The special optical covers for all rebate areas give the final touch for an overall perfect door design:
- The result: a complete, surrounding flush surface in the rebate area, covering entirely the thermal break zones
 - All fitting parts are integrated flush
 - Speeding up assembly: all parts are simply clipped in, for the areas of fittings and locks special pre-fabricated cover parts make the finish very easy
 - Special design for improved thermal performance

6-7 | Gaskets

- Reliable tightness: no problem with the WICSTYLE evo multiple sealing gasket concept:
- Stop gaskets with pre-formed corner pieces
 - Glazing gasket circumferential, without mitre cut
 - Threshold stop gasket with pre-formed corners for efficient installation
 - User-friendly threshold gasket completely covering the threshold

Your benefits

- Significant time savings in the fittings assembly
- Easy implementation of visual and technical demands
- Dependable high quality for lasting customer's satisfaction



WICSTYLE 65 evo Hinged doors

WICSTYLE 65 evo with its flush leaf design in 65 mm system depth and a comprehensive application range is perfectly qualified for highest demands in design, technological quality and performance. Due to its favourable price/performance ratio it constitutes an economical aluminium door solution for almost any requirement.

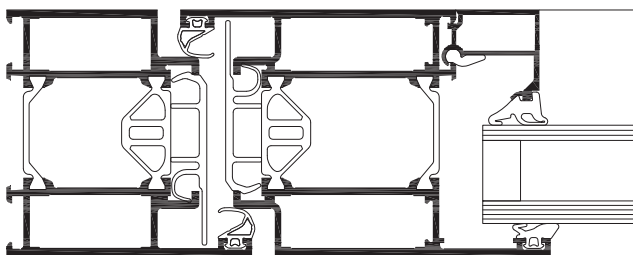

System test results / CE product pass in accordance with DIN EN 14351-1:2006+A1:2010

Air permeability:	Class 4
Watertightness:	Until class 7A
Resistance to wind load:	Class C2
Acoustic performance:	R_w (C;Ctr) until 43 (-2;-5) dB
Operating forces:	Class 2
Load bearing capacity of safety devices:	Fulfilled
Mechanical strength:	Class 3
Repeated opening / closing:	Until class 7 (500,000 cycles)
Impact resistance:	Class 1
Behaviour between different climates:	Until class 2(e) 2(d)
Burglar resistance:	RC1N, RC2N, RC2, RC3
Bullet resistance:	Until FB4
Quality assurance:	Certified according to ISO 9001:2008

Specific application data see ift product pass

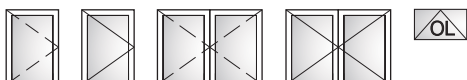

Technical performance:

Profile technology:

- High insulation multi-chamber system in symmetric design, quality assured thermal insulator connection
- For single and double leaf hinged doors
- For inward and outward opening
- For glass or panels with infill thickness from 3 mm to 50 mm
- Various threshold profiles with or without thermal break, also barrier free
- Fanlights, lateral glazings fixed or openable in combination with WICLINE evo window series

Thermal insulation:

- U_f values: from 1.8 to 2.1 W/(m²K)
- U_d values: until 1.3 W/(m²K)

Fittings:

- Butt hinge
- Screwed hinge
- Leaf sizes (w x h): 1400 mm x 2520 mm
- Max. leaf weight: until 200 kg, for bullet resistance with additional hinges until 400 kg

Additional designs:

- Double action doors
- Integration frame for stick façades
- Burglar resistance in classes RC1 to RC3
- Bullet resistance in class FB4
- Leaf overlapping infill on one side or on both sides

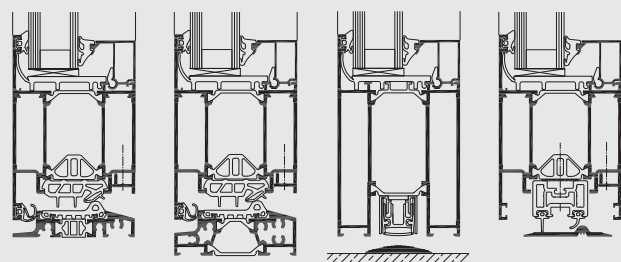

WICSTYLE threshold options

WICSTYLE 75 evo
Hinged doors



With 75 mm profile depth, WICSTYLE 75 evo puts itself ahead in terms of thermal insulation and physical features. Its outstanding technical performance and application range make it the ideal door solution for all current and future requirements in architecture, both in new buildings and in renovations.

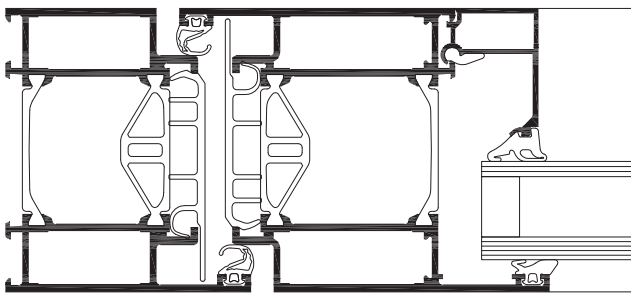

System test results / CE product pass in accordance with DIN EN 14351-1:2006+A1:2010

Air permeability:	Until class 4
Watertightness:	Until 7A
Resistance to wind load:	Class C2
Acoustic performance:	R_w (C;Ctr) until 43 (-2;-5) dB
Operating forces:	Class 2
Load bearing capacity of safety devices:	Fulfilled
Mechanical strength:	Class 3
Repeated opening / closing:	Until class 7 (500,000 cycles)
Impact resistance:	Class 1
Behaviour between different climates:	Until class 2(e) 2(d)
Burglar resistance:	RC1N, RC2N, RC2, RC3
Bullet resistance:	Until class FB4
Quality assurance:	Certified according to ISO 9001:2008

Specific application data see ift product pass

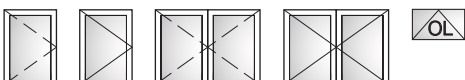

Technical performance:

Profile technology:

- High insulation multi-chamber system in symmetric design, quality assured thermal insulator connection
- For single and double leaf hinged doors
- For inward and outward opening
- For glass or panels with infill thickness from 6 mm to 60 mm
- Various threshold profiles with or without thermal break, also barrier free
- Fanlights, lateral glazings fixed or opening in combination with WICLINE evo window series

Thermal insulation:

- U_f values: from 1.6 to 1.8 W/(m²K), without foam inserts

Fittings:

- Butt hinge
- Screwed hinge
- Concealed hinge*
- Leaf sizes (w x h): 1200 mm x 2520 mm
- Max. leaf weight: until 200 kg, for bullet resistance with additional hinges until 400 kg

Additional designs:

- Double action doors
- Integration frame for stick façades
- Burglar resistance in classes RC1 to RC3
- Bullet resistance in class FB4
- Leaf overlapping infill on one side or on both sides

*on demand

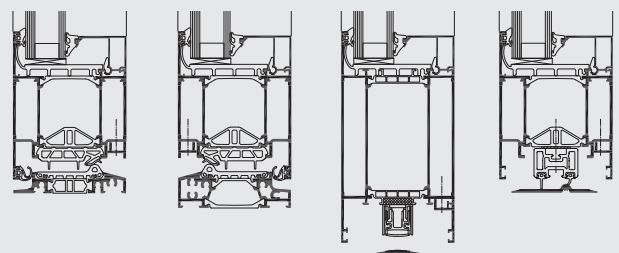

WICSTYLE threshold options

Door options

1 | Hinged door

With 65 mm or 75 mm profile depth, WICSTYLE evo puts itself ahead in terms of thermal insulation and physical features. Its outstanding technical performance and application range make it the ideal door solution for all current and future requirements in architecture, both in new buildings and in renovations.

2 | Leaf overlapping infills

A very homogeneous door design without any joints or gaps can be achieved with leaf overlapping infills. This options also allows for thermal insulation values until $U_g = 0.7 \text{ W}/(\text{m}^2\text{K})$.



Door options

3 | Classic design

Bevelled profile contours and overlapping sashes are characteristic for the aluminium door series WICSTYLE evo in Classic Design. This design underlines a style which is often requested for residential architecture. Ideal for new building and for energetic renovations alike.

4 | Finger protection door

Save operation through efficient prevention of squeezing or shearing risks on the hinge side, combined with the technical performance of the WICSTYLE aluminium door systems: WICSTYLE 65 evo and WICSTYLE 75 evo finger protection doors offer a maximum of advantages in one solution.

5 | Double action door

The WICSTYLE 65 evo serie offers two profile options for single and double sash doors with double action fitting. Both versions are based on the standard door serie and can perfectly be combined with it.

6 | All-glass door

All-glass doors create maximum transparency in a building. WICSTYLE all-glass doors are based on the standard WICSTYLE 65 evo serie, with many identical parts, and thus offer optimal compatibility with other door solutions within the building.

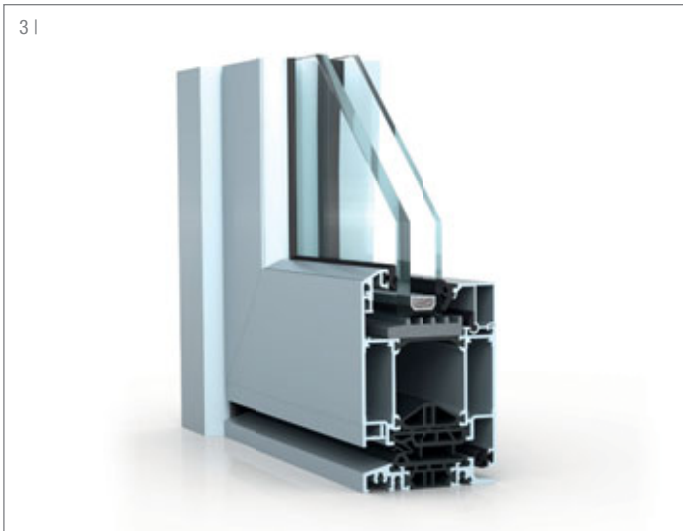

» Tried and tested door series for further requirements

With WICSTYLE evo you fulfil the expectations and demands of your customers in a most individual way. For certain applications however one of the additional systems within the WICSTYLE door series may offer specific advantages and so become the best choice.

Quality, versatility, safety: whether with WICSTYLE evo or one of the WICSTYLE series for special applications, in any case you will convince every customer with these criteria in the realisation of individual and tailor-made entrance and passage doors.



WICSTYLE 50N / 65N
Hinged door, non-insulated

These aluminium systems are designed specially for use inside buildings or where thermal insulation is not a determining factor. The ranges also meet high standards with regard to functionality, durability and comfort, whilst providing good economy.

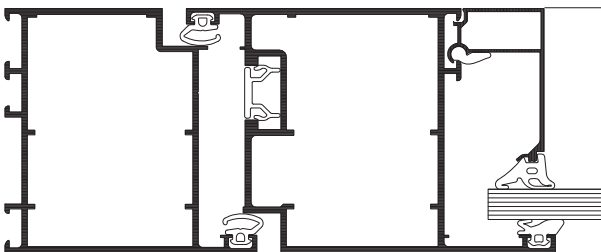
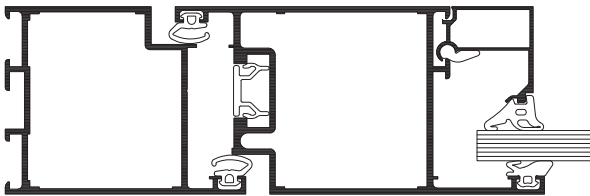

Technical performance:

Profile technology:

- High quality profiles with profile depth 50 mm or 65 mm
- For single and double leaf hinged doors with flush leaf profiles
- For inward and outward opening
- Option of glass-separating or adhesive sash bars
- Fanlights, lateral glazings fixed or opening in combination with WICLINE evo window series
- With mechanical floor gasket or stop gasket
- With butt-hinge or screwed hinge

Special for WICSTYLE 50N:

- Infill thickness 4 mm to 31 mm
- Leaf weight until 150 kg
- Max. leaf size (w x h): until 1300 mm x 2700 mm

Special for WICSTYLE 65N:

- Infill thickness 4 mm to 46 mm (flush leaf) or 8 mm to 57 mm (overlapping leaf)
- Leaf weight until 200 kg
- Max. leaf size (w x h): until 1450 mm x 2350 mm

Additional designs:

- WICSTYLE 65N also possible as smoke control door and with burglar resistance in resistance classes WK1 and WK2

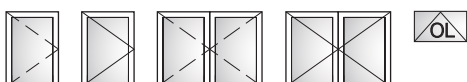

WICSTYLE 77FP

Fire protection door
EI30 / T30 and EI60 / T60

This aluminium door in modular set-up fulfils the requirements of class EI30 and/or class T30/F30 for single and double-leaf doors without the need for fire protection inserts. Simply by adding these, class EI60 and/or T60/F60 are achieved. A full range of fanlight or fixed top or lateral glazings assure a comprehensive application range.

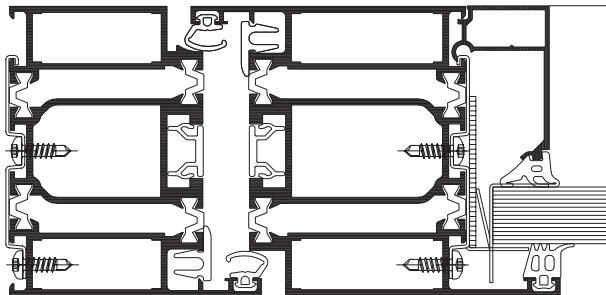

Approval in accordance with national regulations:
Please contact your WICONA sales office



Technical performance:

Profile technology:

- WICSTYLE 77FP is approved for the German market, for other countries the national regulations must be respected
- Tested according to standards DIN 4102 and DIN EN 13501-2
- Execution in fire protection classes EI30/T30/F30 without fire protection inserts
- Execution in fire protection classes EI60/T60/F60 simply by adding fire protection inserts
- For single and double leaf hinged doors, inward and outward opening
- Fixed glazings, lateral lights and fanlights possible in many options
- Identical profile elevation as in the door series WICSTYLE 65 evo and WICSTYLE 75 evo, allowing for a unique design in a building project

Fittings:

- Butt hinge or screwed hinges in the same design as for WICSTYLE standard series, leading to a harmonised building design
- Extensive fittings for requirements such as panic functions, emergency exit seals, electric safety locks, electronic openers, revolving door drive with magnet and bolt contact
- Big unit sizes possible: (w x h) until 1362 mm x 2500 mm (single leaf), or 2500 mm x 2500 mm (double leaf)
- Max. leaf weight: until 200 kg

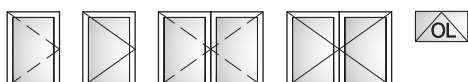

WICSTYLE
Door systems
Emergency exit

In panic situations the safety and rescue possibilities for people in the building are the main concern. In Europe uniform standards for emergency exit door fittings are in application. Within the meaning of these standards, emergency exit door systems are subdivided in emergency exit devices according to EN 179, and panic door exit devices according to EN 1125. Emergency exits acc. to EN 179 are designated to buildings to which the general public does not have access and whose visitors understand the function of the emergency doors.

Panic door exit devices acc. to EN 1125 are used in public buildings where the visitors are not familiar with the function of emergency doors, like schools, hospitals, shopping malls. The WICSTYLE door systems offer a comprehensive range of applications, which can also be combined with other functions and design options.



Technical performance:

Profile technology:

- Doors in accordance with EN 179 (emergency exit devices) or with EN 1125 (panic exit devices)
- Many system options for the emergency application, allowing for a unified door design within the building, irrespective of additional functions
- Single or double leaf possible
- Combination with burglar resistance in classes RC1 and RC2 possible
- Execution in combination with fire protection in classes T30 and T60 and in combination with smoke control possible (national regulations must be respected)



WICSTYLE systems for exit doors according to EN 179 (emergency exit device) and according to EN 1125 (panic exit device)

- WICSTYLE 65 evo Hinged door
- WICSTYLE 75 evo Hinged door
- WICSTYLE evo Classic design
- WICSTYLE evo Finger protection door
- WICSTYLE 65 Non-insulated
- WICSTYLE 77FP Fire protection door

» Comfort access with efficient thermal insulation

WICSTYLE 65ED, the energy-saving automatic sliding door for commercial buildings, is your new access to reduce energy consumption, tested according to the products standard for windows and doors EN 14351-1.

During such periods, in particular, WICSTYLE 65ED with its superb thermal insulation U_d below $1.5 \text{ W}/(\text{m}^2\text{K})$ protects the building reliably against excessive energy loss, thereby making a significant contribution to improving the overall energy balance of the building.



WICSTYLE 65ED
Energy-saving
automatic sliding door



WICSTYLE 65ED, the energy-saving automatic sliding door for commercial buildings, was developed in collaboration with the Swiss global market leader Gilgen Door Systems AG, on the basis of the WICSTYLE 65 profile. Automatic sliding doors have short open and close cycles that have been optimised for throughput. Therefore, when in operation they retain the largest amount of warmth within the building. A major role in energy efficiency, however, is played by the time in which the door remains permanently shut – such as overnight. During such periods, in particular, WICSTYLE 65ED protects the building reliably against excessive energy loss, thereby making a significant contribution to improving the overall energy balance of the building.

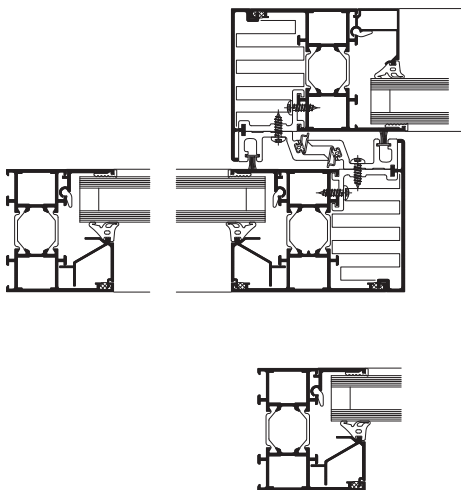

Technical performance:

Profile technology:

- Safety tested in accordance with the personal safety regulations in standard DIN 18650
- Approved complete door device (both thermally insulated profile system and drive unit), according to DIN EN 14351-1
- Leading thermal insulation values with U_g values below 1.5 W/(m²K)
- Up to 70 % less energy loss in closed situation
- Improved tightness compared to surrounding double gaskets in labyrinth application, with values comparable to residential entrance doors
- Reliable automation by Gilgen Door Systems
- Ideal for both new builds and renovations
- Attractive appearance due to narrow sight lines and coordinated integration of the door drive
- Infill thickness from 24 mm to 27 mm
- Option of single or double-leaf sliding versions, with or without lateral glazing
- Easy integration of additional functions and fittings, such as multipoint locks for increased burglar resistance

Thermal insulation:

- U_g values: below 1.5 W/(m²K)

Drive system / fittings:

- Single or double leaf door devices
- Drive systems SLA, SLX and SLX redundant
- Possible for emergency exits
- Infill weights: until 150 kg
- Leaf formats (w x h): until 2000 mm x 3000 mm

System test results / CE product pass in accordance with DIN EN 14351-1

Air permeability:	Class 2
Watertightness:	Class 5A
Resistance to wind load:	Class B1
Quality assurance:	Certified according to ISO 9001:2008

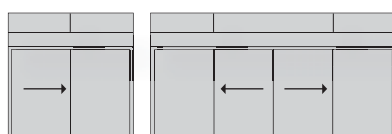

» WICSLIDE sliding units – simply closer to nature

If your customers want to enjoy the scenery outdoors directly from their desks or living rooms, you can offer the perfect solution with WICSLIDE sliding systems. For all demands, adapted to the building and space situation, the various

system variants as sliding, lifting-sliding and folding-sliding application always show the most suitable solution in performance and function. Of course always in combination with most advanced thermal insulation and tightness.





„Back to nature“ – all it takes is a quick twist of the hand and, with WICSLIDE's folding and sliding systems, living spaces, seminar or conference rooms will open out into the garden or patio. Extremely light and quiet: qualities that are ensured by high-quality fittings and robust guide rails with easy glide properties. As with all WICONA product ranges, there are various options available here too – double or triple track, with sliding, lifting/sliding or folding/sliding functionality, which can be combined with fixed panels.



1 | Lifting sliding doors WICSLIDE 160 / WICSLIDE 23 / WICSLIDE 26
 2 | Folding / sliding doors WICSLIDE 65FS
 3 | Sliding doors WICSLIDE 24E / WICSLIDE 24EN

WICSLIDE 160
Lifting sliding door

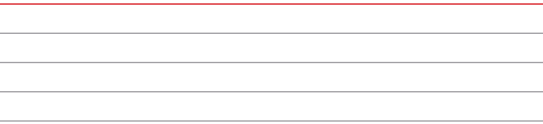

The new WICSLIDE 160 lifting sliding system combines excellent thermal insulation with highest functionality and design. Impressive leaf dimensions and enduring operation comfort are your guarantors for maximum customer satisfaction. With state-of-the-art technology and innovative advantages in fabrication WICSLIDE 160 is a high-tech product that sets new standards.

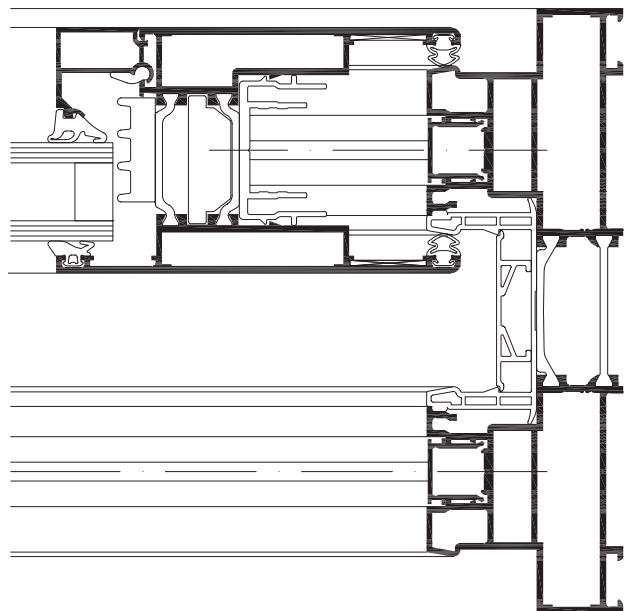

System test results / CE product pass in accordance with DIN EN 14351-1

Air permeability:	Class 4
Watertightness:	E1350A
Resistance to wind load:	Class C3
Quality assurance:	Certified according to ISO 9001:2008

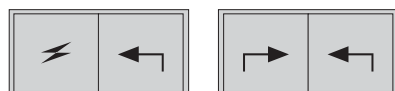

Technical performance:

Profile technology:

- Improved hooking zone between the leaves for enhanced thermal insulation and tightness
- Construction depth 160 mm (double track)
- Special frame profiles with multi function zone
- Barrier free threshold possible
- Enduring comfort operation due to optimised running carriage technology
- Hooking zone without visible screws
- Optional with fixed glazing or fixed sash
- Easy integration in WICTEC 50 and WICTEC 60 stick system curtain walling

Thermal insulation:

- U_w values: below 1.1 W/(m²K)

Fittings:

- Lifting sliding fittings, running carriage with integrated brush for permanent cleaning of the tracks
- Support device in the lowering of the leaf, resulting in reduced operation forces
- Lock plates with DPS technology (DirectPositioningSystem)
- Leaf dimensions (w x h): until 3240 mm x 3400 mm
- Leaf weight until 400 kg (lifting sliding)



WICSLIDE 65FS
Folding / sliding door

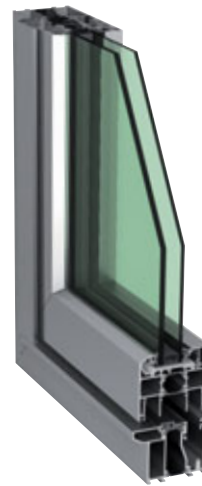

WICSLIDE 65FS is the ideal solution when there is only limited room for the opened elements. Due to its excellent technical values, WICSLIDE 65FS can be used as a direct partition, for example in conservatories, meeting areas, conference rooms, car show rooms and hotels.

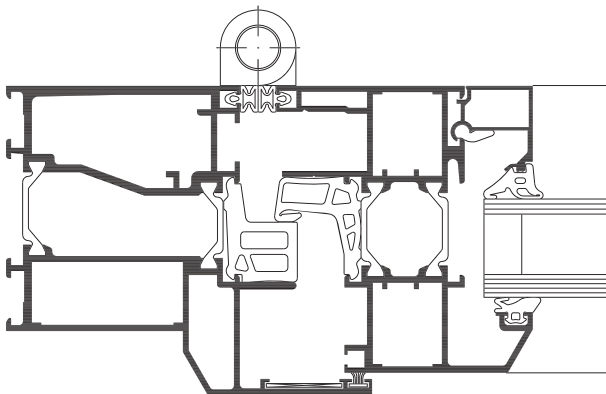

System test results / CE product pass in accordance with DIN EN 14351-1

	Outward opening	Inward opening
Air permeability:	Class 4	Class 3
Watertightness:	9A	7A
Resistance to wind load:	Until Class C3 / B3	Class C2 / B2
Operating forces:	Class 1	Class 1
Mechanical strength:	Class 4	Class 4
Repeated opening / closing:	Class 2 (10,000 cycles)	Class 2 (10,000 cycles)
Quality assurance:	Certified according to ISO 9001:2008	

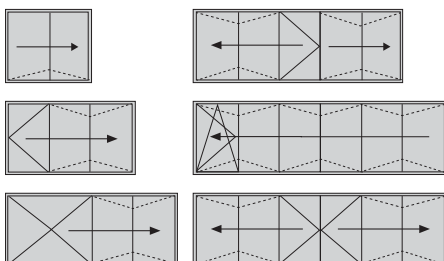

Technical performance:

Profile technology:

- Slim profile construction with only 65 mm profile depth
- Infill thickness from 3 mm to 47 mm
- Folding / sliding opening type with 2 to 7 leaves, partition to the left or to the right
- Reduced space requirement for open leaves
- Easy and safe operation
- Possible with barrier free threshold for undisturbed passage

Thermal insulation:

- U_w values: until 1.3 W/(m²K)

Fittings:

- Folding sliding doors with single or double turn sash
- Integrated turn/tilt or tilt sashes possible
- Leaf dimensions (w x h): until 2500 mm x 1100 mm
- Leaf weight until 100 kg



WICSLIDE 23 Lifting sliding door

The special characteristics of WICSLIDE 23 make this sliding and lifting/sliding door a favourite for use as a partition. The construction can be executed with very high leaf weights of up to 300 kg. WICSLIDE 23 is weather-resistant for outdoor use and is very well suited to conservatories, swimming pools and construction projects with large expanses of glass. It can also be used in industrial construction.

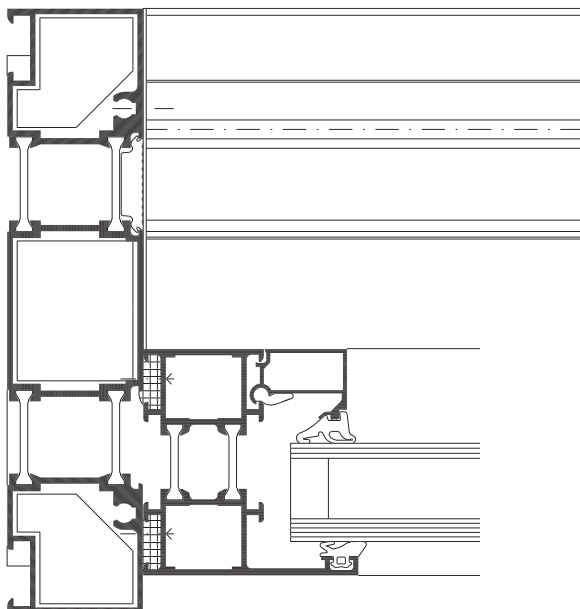

System test results / CE product pass in accordance with DIN EN 14351-1

Air permeability:	Class 4
Watertightness:	9A
Resistance to wind load:	Class C3 / B5
Operating forces:	Class 1
Burglar resistance:	Until WK2
Repeated opening / closing:	Class 2 (10,000 cycles)
Quality assurance:	Certified according to ISO 9001:2008

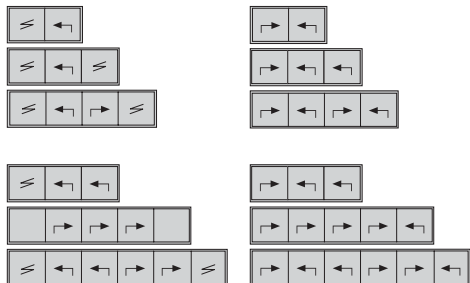

Technical performance:

Profile technology:

- Double or triple-leaf frames with compact dimensions of 160 mm (double track) or 240 mm (triple track), leaf 60 mm
- Infill thickness from 4 mm to 42 mm
- Extensive freedom of design with 2 to 6 leaves
- Combination with fixed panels or fixed leaves possible
- Easy integration in WICTEC 50 and WICTEC 60 stick system curtain walling

Thermal insulation:

- U_w values: until 1.3 W/(m²K)

Fittings:

- Lifting/sliding doors or windows, or sliding doors or windows
- Leaf dimensions (w x h): until 3500 mm x 2600 mm
- Leaf weight until 300 kg



WICSLIDE 26
Lifting sliding door



WICSLIDE 26 is a lifting door or lifting/sliding door which is principally used as a room partition and as exit to balconies. For these applications in particular, this range impresses as a delicate solution with a corresponding refined look. In addition, WICSLIDE 26 can also be used for structures in industry construction.

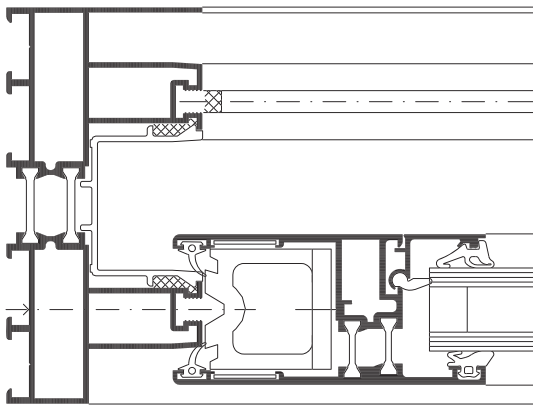

System test results / CE product pass in accordance with RAL GZ695 / DIN EN 14351-1

	Lifting/sliding	Sliding
Air permeability:	Class 4	Class 3
Watertightness:	9A	7A
Resistance to wind load:	Until Class C3 / B3	Class C3 / B3
Operating forces:	Class 1	Class 1
Impact resistance:	Class 5	Class 5
Burglar resistance:	Until WK2	Until WK2
Repeated opening / closing:	Class 2 (10,000 cycles)	Class 2 (10,000 cycles)
Quality assurance:	Certified according to ISO 9001:2008	

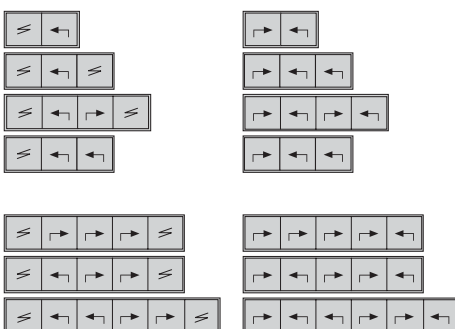

Technical performance:

Profile technology:

- Double or triple-leaf frames with compact dimensions of 105 mm (double track) or 160 mm (triple track), leaf 40 mm
- Infill thickness from 5 mm to 24 mm
- Extensive freedom of design with 2 to 6 leaves
- Combination with fixed panels or fixed leaves possible
- Easy integration in WICTEC 50 and WICTEC 60 stick system curtain walling

Thermal insulation:

- U_w values: until 1.6 W/(m²K)

Fittings:

- Lifting sliding doors or windows, or sliding doors or windows
- Leaf dimensions (w x h): until 2450 mm x 2100 mm
- Leaf weight until 150 kg



WICSLIDE 24E / WICSLIDE 24EN
Sliding door



WICSLIDE 24E is used as a classic sliding window or as a sliding door with slim frame design. The choice between thermally insulated and non-insulated options allows for an ideal adaptation to each application. In the double or triple-track design, structures with up to six leaves and very large opening widths are possible.

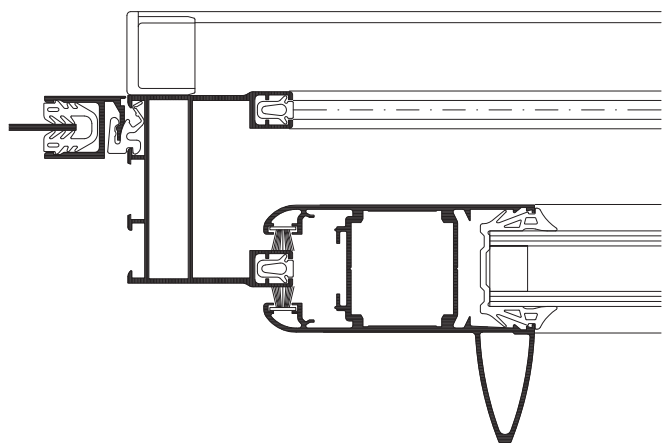
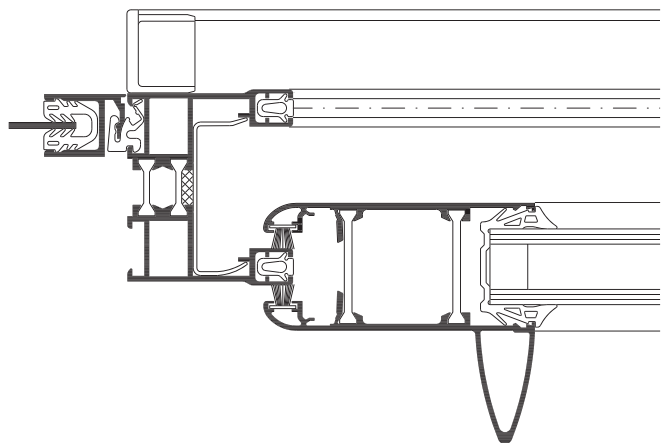

Technical performance:

Profile technology:

- Double or triple-leaf frames with compact dimensions of 50 mm (double track) or 92 mm (triple track), leaf 34 mm
- Infill thickness from 8 mm to 24 mm
- Slim frame design
- Identical design for thermally insulated and non-insulated version

Fittings:

- Sliding doors / windows
- 2 to 6 leaves
- Leaf dimensions (w x h): until 1800 mm x 2500 mm
- Leaf weight until 120 kg



WICONA: Solutions for ambitious architecture

FAÇADES

WICTEC

- Stick curtain walls
- Passive house curtain walls
- Unitised curtain walls
- Double skin façades
- Structural glazing curtain walls
- Insertion windows



WICTEC 50
WICTEC 60



WICTEC 50EL
WICTEC EL60



WICTEC 50SG



WICLINE 90SG

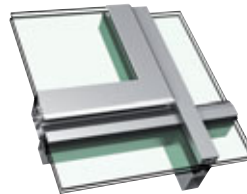

WICTEC



WICLINE 65 evo
WICLINE 75 evo

WINDOWS

WICLINE

- Punched / ribbon windows
- Coupled windows
- Hybrid windows



WICLINE 65 evo
WICLINE 75 evo



WICLINE 125



WICLINE 215

SUNSHADE

WICSOLAIRE

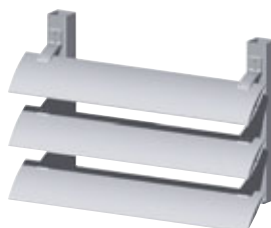

WICSOLAIRE

North East Europe (NEE)
Hydro Building Systems GmbH
Söflinger Straße 70
(From 01.04.2013: Einsteinstr. 61)
89077 Ulm
Phone +49 731 3984-0
www.wicona.de

North West Europe (NWE)
Hydro Building Systems S.a.r.l.
Rue Jean-Baptiste Godin
Parc d'Activités Le Plateau
02200 Courmelles
Téléphone +33 3 23 59 82 00
www.wicona.fr

South East Europe (SEE)
Hydro Building Systems S.p.A.
Customer Service
Via Stazione 133/X
30035 Ballò di Mirano (VE)
Telefono +39 041 51 38 633
www.wicona.it

South West Europe (SWE)
Hydro Building Systems S.I.
Southwest SLU
Camí de Ca n'Ametller, 18
08195 Sant Cugat del Vallès
Barcelona
Teléfono +34 902 22 23 23
www.wicona.es

International
Hydro Building Systems S.a.r.l.
270 rue Léon Joulin
BP 63709
31037 Toulouse cedex 01
Téléphone +33 5 61 31 26 26
www.wicona-int.com